

S2, S2.1, S3, S4, S5, S6, S7, S8, S9

S12, S13, S16

S2.2, S15, S17

S2.3

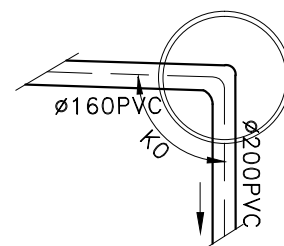
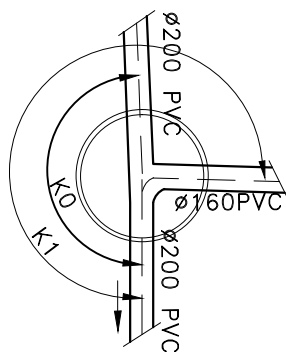
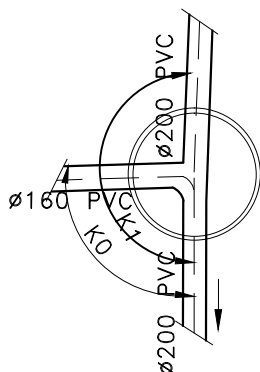

S10, S11

S10.1, S10.2, Tr1, Tr1a

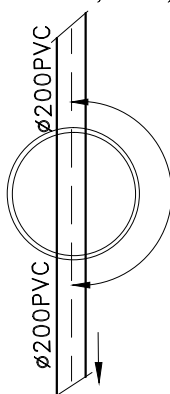
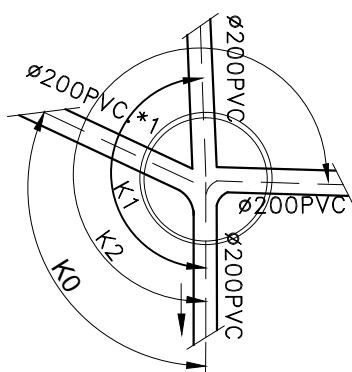

S10.3, S14, S18

S17.1

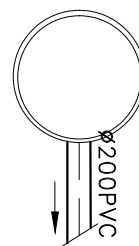
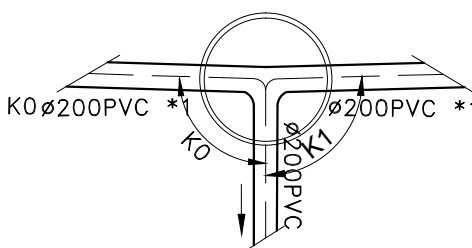

	S2	S2.1	S2.2	S2.3	S3	S4	S5	S6	S7	S8	S9	S10	S10.1	S10.2	S10.3	S11	S12	S13	Tr1	Tr1a
K0	87,0°	89,0°	97,0°	82,0°	94,0°	90,0°	87,0°	92,0°	90,0°	84,0°	90,0°	98,0°	180,0°	180,0°	77,0°	91,0°	91,0°	90,0°	179,0°	180,0°
K1	184,0°	181,0°	198,0°	-	181,0°	181,0°	180,0°	181,0°	180,0°	181,0°	181,0°	179,0°	-	-	104,0°	167,0°	180,0°	180,0°	-	-
K2	-	-	-	-	-	-	-	-	-	-	-	273,0°	-	-	-	229,0°	-	-	-	-

	S14	S15	S16	S17	S18
K0	74,0°	84,0°	89,0°	84,0°	93,0°
K1	150,0°	149,0°	179,0°	162,0°	91,0°

UWAGA:

*1 – Włoty w S10.3, S11 i włoty w S18 z rur $\varnothing 160\text{PVC}$



Zakład Usług Komunalnych S.C.

70-402 Szczecin, ul.Kaszubska 59/6, tel.:4333913

Nazwa inwestycji WYKONANIE PROJEKTU BUDOWLANEGO DLA ZADANIA: BUDOWA SIECI KANALIZACJI SANITARNEJ Z PODŁĄCZENIAMI DO POSESJI W UL. MARKIEWICZA OD UL. SZKOLNEJ DO UL. MAŁOPOLSKIEJ W ŚWINOUJŚCIU	Proj. K.Baraniński Nr upr.231/SZ/82	Nr umowy 107/17
Temat opracowania SIEĆ WODOCIĄGOWA I SIEĆ KANALIZACJI SANITARNEJ Z PRZYŁĄCZAMI	Opr. J.Chrzanowska	Nr rys. 4
Nazwa rysunku KINETY STUDNI BETONOWYCH	Spr. A. Poterek Nr upr.ZAP/0233/PWOS/13	
Branża wod.-kan.	Faza P.B.W.	Data 07.2018r.
		Skala -